

THIS DOCUMENT IS SUBJECT TO CHANGE WITHOUT NOTICE. IT IS CONFIDENTIAL AND A PROPERTY OF AMPHENOL LTW. DISCLOSURE TO THIRD PARTY HAS TO BE AUTHORIZED BY AMPHENOL LTW.

REV.	ECN NO.	DATE	SIGN	DESCRIPTION
B	C230296	2023/05/02	Eagle	\triangle B x I

DT-ACM-XXRMM-RHA30

For 12P

G3: 3Pin
 G4: 4Pin
 06: 6Pin
 08: 8Pin
 12: 12Pin

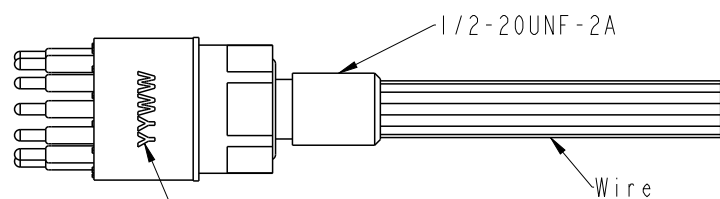
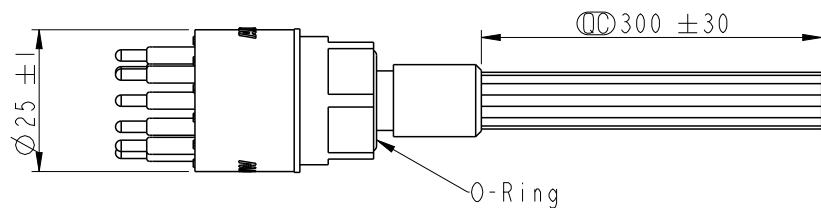
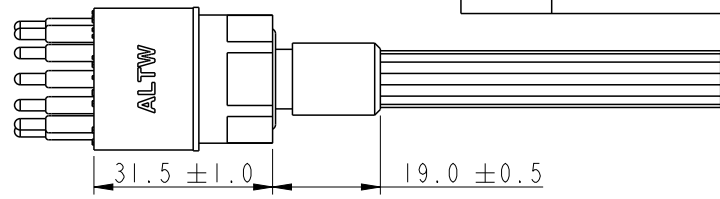
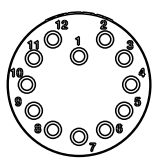

Ⓞ Date Code(Laser mark)
 YY(年)
 WW(週)

11.1 (Max.)/6.4 (Min.)

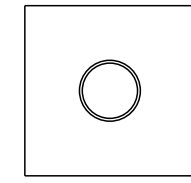

Panel cut out (screw type)

11.1 (Max.)/6.4 (Min.)

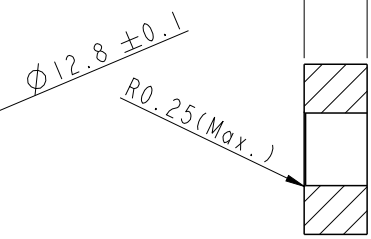
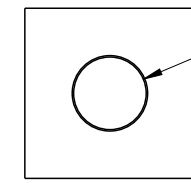

Panel cut out (hole type)

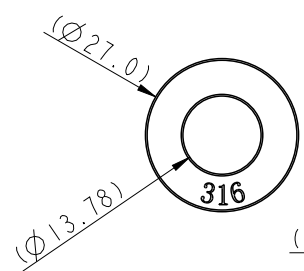

Washer

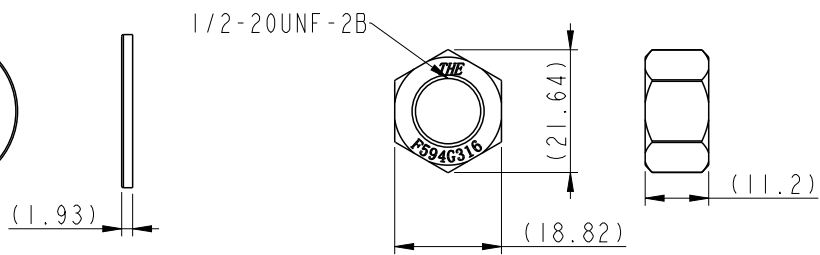

Nut

Note:

- * Ⓞ Important Dimension.
- * Waterproof Rate: Abyssopelagic 4000M, Mated.
- * Connector
 Housing : Rubber, Black.
 Pin : Copper Alloy, Gold Plated.
 O-Ring: Rubber, Black.
 Shield: Metal.
 Nut: Metal.
 Washer: Metal.
- * Wire:
 UL10393 18 AWG, OD 1.81mm for 3P/4P
 UL1815 22 AWG, OD 1.46mm for 6P/8P
 UL1815 20 AWG, OD 1.56mm for 12P
- * Washer and nut are packed separately in PE bag.

UNIT: mm TOLERANCE ±0.5	TITLE DT, ABY CIRCULAR MICRO REAR FASTENED, M, M			<h1 style="text-align: center;">Amphenol LTW</h1> <p style="text-align: center;">安費諾亮泰企業股份有限公司</p>	ITEM NO	DRAWN BY Eagle	DATE 2022/11/08
	SCALE 1:1	SIZE A4	SHEET 1 OF 4		DWG NO DT-ACM-XXRMM-RHA30	CHECKED BY Aric	DATE 2022/11/08
	REV. B	WC-REV. A.5	Ⓞ: Inspection item		CUSTOMER ALTW	APPROVED BY Max	DATE 2022/11/08

THIS DOCUMENT IS SUBJECT TO CHANGE WITHOUT NOTICE. IT IS CONFIDENTIAL AND A PROPERTY OF Amphenol LTW. DISCLOSURE TO THIRD PARTY HAS TO BE AUTHORIZED BY Amphenol LTW.

Special square thread
特殊方形螺牙

For 3P/4P/6P/8P

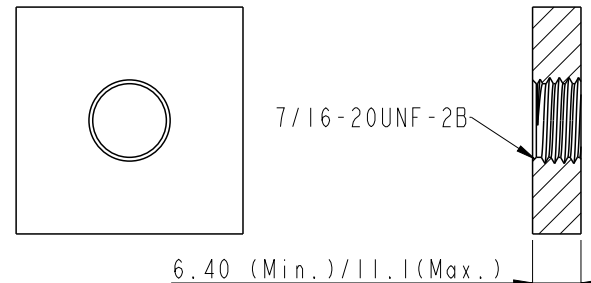
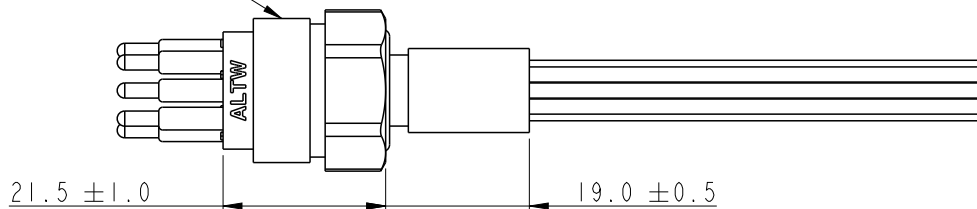

Panel cut out (screw type)

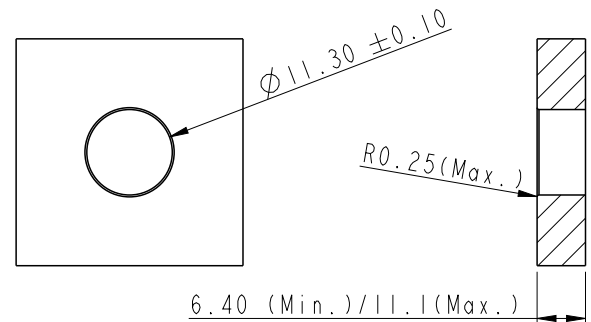
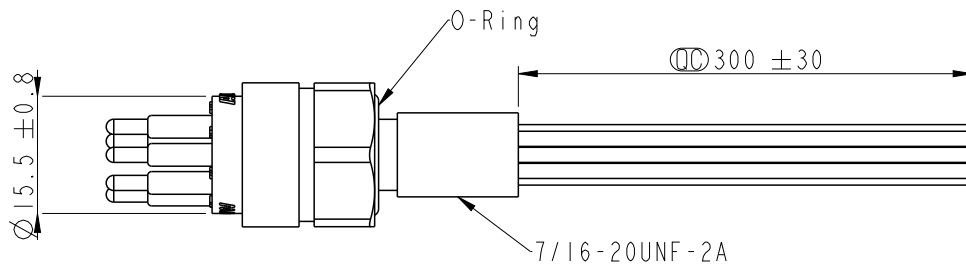

Panel cut out (hole type)

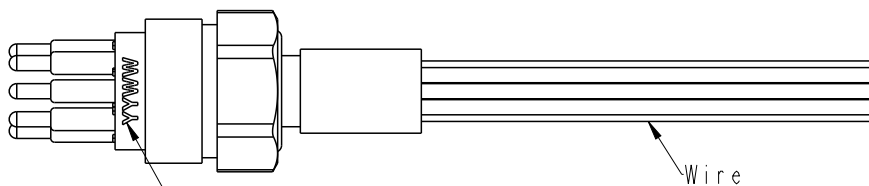

☉ Date Code(Laser mark)

YY(年)

WW(週)

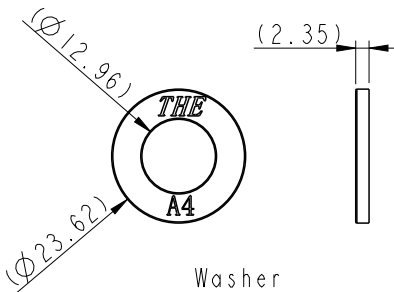

Washer

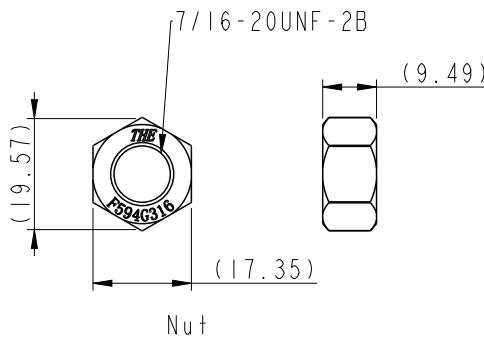

Nut

UNIT: mm

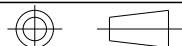

TITLE DT, ABY CIRCULAR MICRO REAR FASTENED, M, M			
SCALE 1:1	SIZE A4	SHEET 2 OF 4	
REV. B	WC-REV. A.5	☉: Inspection item	

Amphenol LTW

安費諾亮泰企業股份有限公司

ITEM NO	DRAWN BY Eagle	DATE 2022/11/08
DWG NO DT-ACM-XXRMM-RHA30	CHECKED BY Aric	DATE 2022/11/08
CUSTOMER ALTW	APPROVED BY Max	DATE 2022/11/08

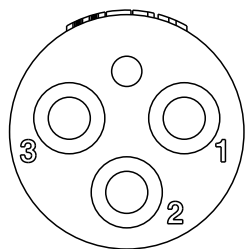

Pin Assignment(Front View)

- Pin Out (3P)
 1 Black(黑) 18AWG
 2 White(白) 18AWG
 3 Red(紅) 18AWG

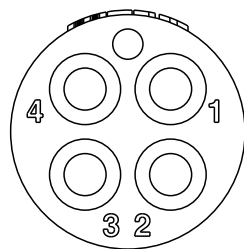

Pin Assignment(Front View)

- Pin Out (4P)
 1 Black(黑) 18AWG
 2 White(白) 18AWG
 3 Red(紅) 18AWG
 4 Green(綠) 18AWG

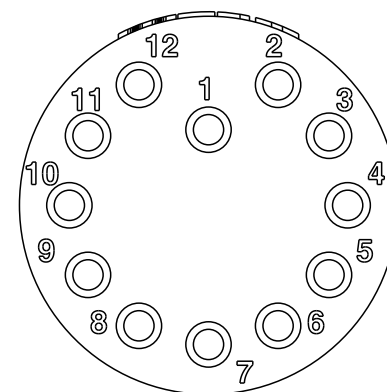

Pin Assignment(Front View)

- Pin Out (12P)
 1 Black(黑) 20AWG
 2 White(白) 20AWG
 3 Red(紅) 20AWG
 4 Green(綠) 20AWG
 5 Orange(橙) 20AWG
 6 Blue(藍) 20AWG
 7 White/Black(白/黑) 20AWG
 8 Red/Black(紅/黑) 20AWG
 9 Green/Black(綠/黑) 20AWG
 10 Orange/Black(橙/黑) 20AWG
 11 Blue/Black(藍/黑) 20AWG
 12 Black/White(黑/白) 20AWG

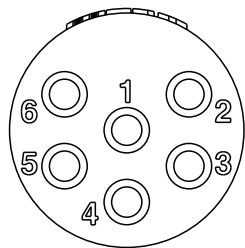

Pin Assignment(Front View)

- Pin Out (6P)
 1 Black(黑) 22AWG
 2 White(白) 22AWG
 3 Red(紅) 22AWG
 4 Green(綠) 22AWG
 5 Orange(橙) 22AWG
 6 Blue(藍) 22AWG

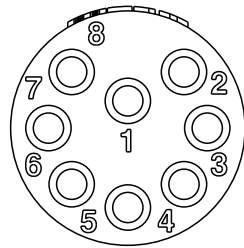

Pin Assignment(Front View)

- Pin Out (8P)
 1 Black(黑) 22AWG
 2 White(白) 22AWG
 3 Red(紅) 22AWG
 4 Green(綠) 22AWG
 5 Orange(橙) 22AWG
 6 Blue(藍) 22AWG
 7 White/Black(白/黑) 22AWG
 8 Red/Black(紅/黑) 22AWG

UNIT:mm
 TOLERANCE

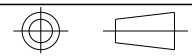

TITLE DT, ABY CIRCULAR MICRO REAR FASTENED, M, M			
SCALE 1:2	SIZE A4	SHEET 3 OF 4	
REV. B	WC-REV.	QC: Inspection item	

Amphenol LTW
 安費諾亮泰企業股份有限公司

ITEM NO	DRAWN BY Eagle	DATE 2022/11/08
DWG NO DT-ACM-XXRMM-RHA30	CHECKED BY Aric	DATE 2022/11/08
CUSTOMER ALTW	APPROVED BY Max	DATE 2022/11/08

THIS DOCUMENT IS SUBJECT TO CHANGE WITHOUT NOTICE. IT IS CONFIDENTIAL AND A PROPERTY OF AMPHENOL LTW. DISCLOSURE TO THIRD PARTY HAS TO BE AUTHORIZED BY AMPHENOL LTW.

△B

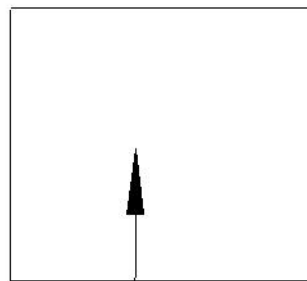
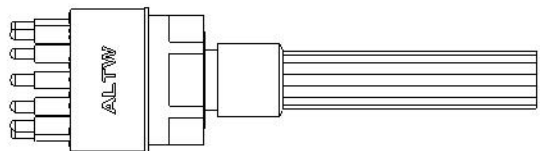

Tray

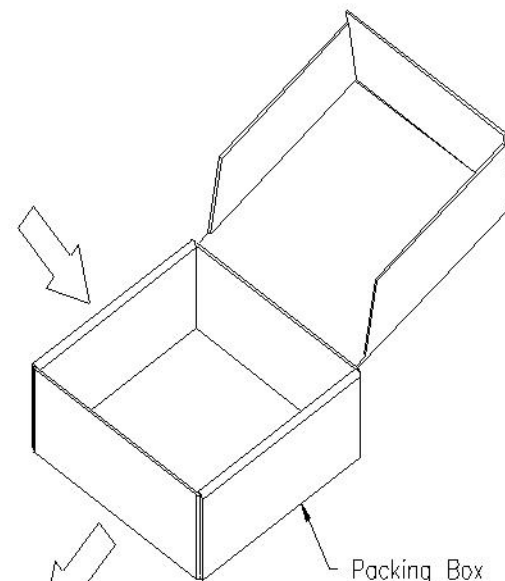

Packing Box

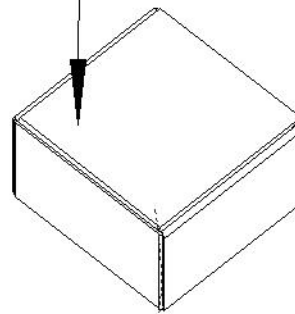

年 月 ALTW 合格品 RoHS2.0

料號: _____ 廠商: 昆山安費諾正日電子



數量: _____ PC 日期: _____

Lot No: _____ 版本: _____



採購單號: _____



廠商料號: _____

Packing Information

Minimum Packing Quantity (MPQ)

PIN	PCS/Tray	Tray/Box
3P	10	2
4P	10	2
6P	10	2
8P	10	2
12P	8	2

Connector will be packed in PE bag if order is less than MPQ

UNIT: mm

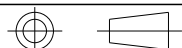

TOLERANCE
±0.5

TITLE DT, ABY CIRCULAR MICRO REAR FASTENED, M, M			
SCALE 1:1	SIZE A4	SHEET 4 OF 4	
REV. B	WC-REV. A.5	Ⓞ: Inspection item	

Amphenol LTW

安費諾亮泰企業股份有限公司

ITEM NO	DRAWN BY Eagle	DATE 2022/11/08
DWG NO DT-ACM-XXRMM-RHA30	CHECKED BY Aric	DATE 2022/11/08
CUSTOMER ALTW	APPROVED BY Max	DATE 2022/11/08